



- + Poteau à encoches
- + Facilité de pose
- + Polyvalent
- + Large gamme d'accessoires



Habitations
et jardins
individuels



Logements
collectifs



Usines et sites
industriels

*conditions de garantie : nous contacter









Entraxe poteaux : 2 555mm
(avec panneau Giga®)

Traitement de surface

Poteau acier galvanisé : charge zinc de 70 g/m².
Plastification haute adhérence par poudrage électrostatique.
Épaisseur mini 80 µm.

Coloris

 Vert RAL 6005	 Noir RAL 9005	 Gris RAL 7030
 Gris RAL 7016	 Blanc RAL 9010	 Autre RAL sur demande

Descriptif technique

MATIÈRE	Acier nuance DX51D+Z140
DIMENSIONS PROFIL	80 x 60 x 1 mm
I/V	6 cm ³
FIXATION	Encoches (pas de 100 mm)
CHAPEAU	Noir anti-uv
HAUTEUR	De 700 à 3000 mm
RÉSISTANCE À 1M DU SOL	240 kg

Hauteur poteau à sceller (mm)**	Hauteur poteau sur platine (mm)	Hauteur panneau (mm)
1100*	700	630
1300	900	830
1600*	1100	1030
1700	1300	1230
2000*	1600*	1430
2000	1600	1530
2200	1700	1630
2200	1800	1730
2500*	2000*	1830
2500	2000	1930
2500	-	2030
3000*	-	2230
3000	-	2430

*découpe à prévoir
**=sans dalle de soubassement

Profil poteau

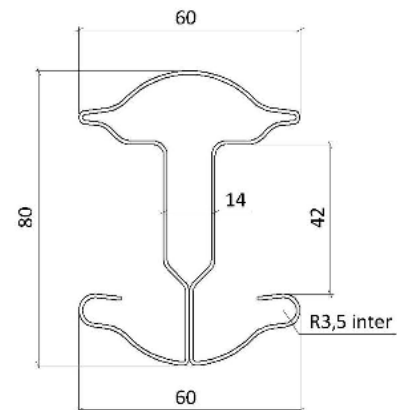

Accessoires poteau

- > Platine à manchonner
- > Platine triangulaire soudée (sur demande)
- > Platine GIGA® renforcée
- > Platine équerre (sur demande)
- > Platine anglaise soudée (sur demande)
- > Bavolet à manchonner simple/double
- > Bavolet grillagé
- > Jonction
- > Capuchon GIGA

Accessoire de pose

- > Pince de montage

Références poteau

Vert – RAL 6005		
Hauteur poteau à sceller (mm)	Code article	Gencode
700	24007031	3464784098313
900	24009031	3464784001313
1100	24011031	3464784003317
1300	24013031	3464784005311
1600	24016031	3464784060310
1700	24017031	3464784009319
1800	24018031	3464784011312
2000	24020031	3464784012319
2200	24022031	3464784013316
2500	24025031	3464784016317
3000	24030031	3464784018311

Noir – RAL 9005		
Hauteur poteau à sceller (mm)	Code article	Gencode
700	24007034	3464784098344
900	24009034	3464784001344
1100	24011034	3464784003348
1300	24013034	3464784005342
1600	24016034	3464784060341
1700	24017034	3464784009340
1800	24018034	3464784011343
2000	24020034	3464784012340
2200	24022034	3464784013347
2500	24025034	3464784016348
3000	24030034	3464784018342

Gris - RAL 7016		
Hauteur poteau à sceller (mm)	Code article	Gencode
700	24007033	3464784098337
900	24009033	3464784001337
1100	24011033	3464784003331
1300	24013033	3464784005335
1600	24016033	3464784060334
1700	24017033	3464784009333
1800	24018033	3464784011336
2000	24020033	3464784012333
2200	24022033	3464784013330
2500	24025033	3464784016331
3000	24030033	3464784018335

Référence capuchon

Couleurs	Code article	Gencode
Noir - Anti-UV	82150104	3464788250144

Dalle de soubassement



Association panneaux

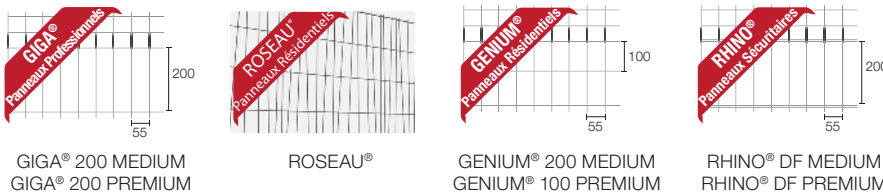

Retrouvez toute la gamme d'accessoires sur les fiches techniques associées.

Données logistiques

H. poteau (mm)	Poids poteau (kg)	Conditionnement palette	Type de stockage	Conditionnement palette			Volumétrie cdt (m³)	Poids cdt (kg)	Gerbabilité stockage
				L	l	h			
700	1,68	54	Palette	700	770	400	0,22	102,72	6
900	2,32	54	Palette	900	770	400	0,28	137,28	6
1100	2,84	54	Palette	1100	770	400	0,34	165,36	6
1300	3,35	54	Palette	1300	770	400	0,40	192,9	6
1600	4,13	54	Palette	1600	770	400	0,49	235,02	6
1700	4,39	54	Palette	1700	770	400	0,52	249,06	6
1800	4,64	108 (sauf blanc 54)	Palette	1800	770	620	0,86	513,12	6
2000	5,16	108 (sauf blanc 54)	Palette	2000	770	620	0,95	569,28	6
2200	5,68	108 (sauf blanc 54)	Palette	2200	770	620	1,05	625,44	6
2500	6,45	108 (sauf blanc 54)	Palette	2500	770	620	1,19	708,60	6
3000	7,74	54	Palette	3000	770	400	0,92	429,96	6